

Silver Series

SS6x4-000020

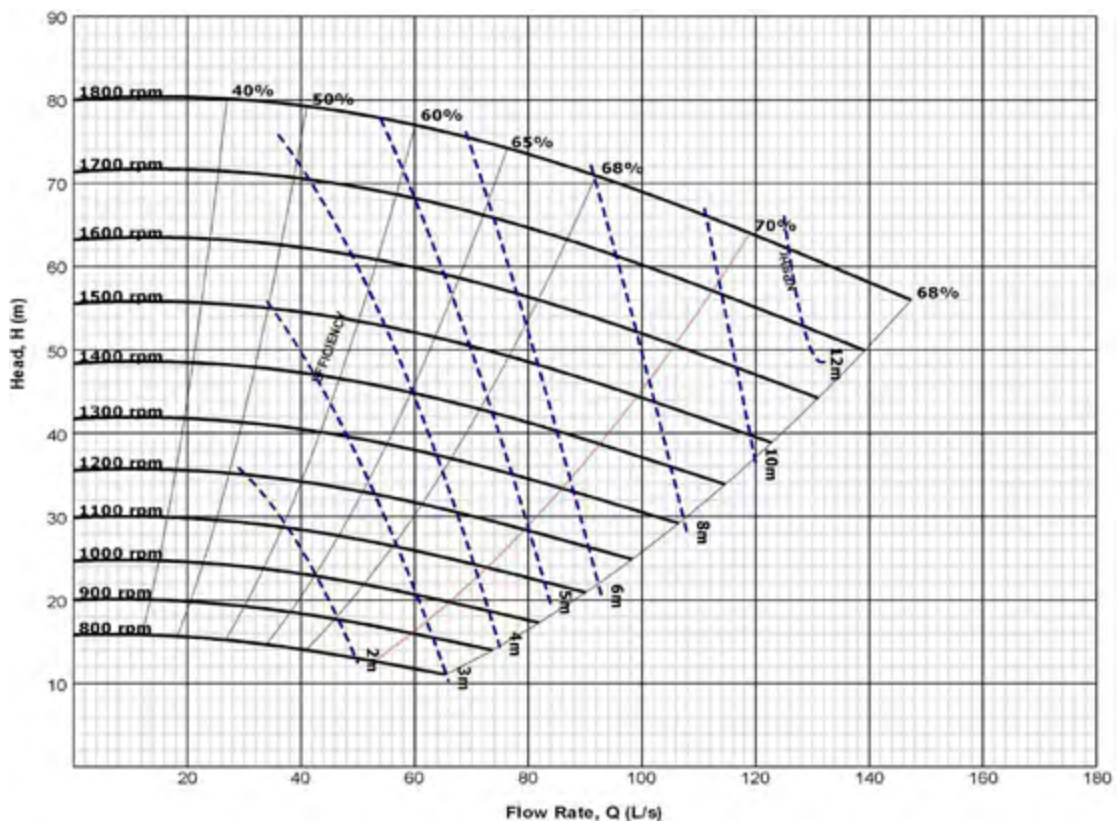

Suction	152 mm (6")
Discharge	101 mm (4")
Maximum RPM	1800
Sealing system	Standard gland packing
Liner material	High chrome
Impeller material	High chrome
Throat bush	High chrome
Maximum motor power	60 kW
Weight-Bare shaft pump	670 kg



NOTE This information is for guidance/reference only. For application specific drawings and curves, please contact your nearest authorised distributor at slurrypro.com

Silver Series

SS6x4-000020

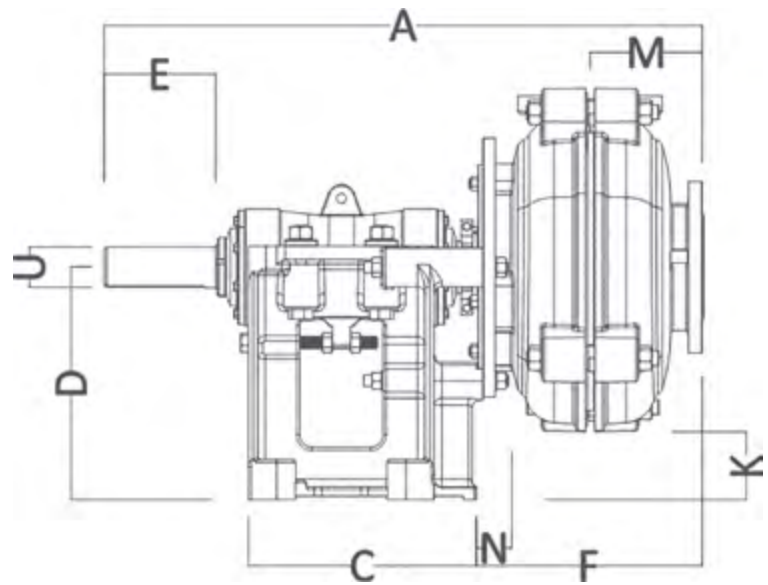
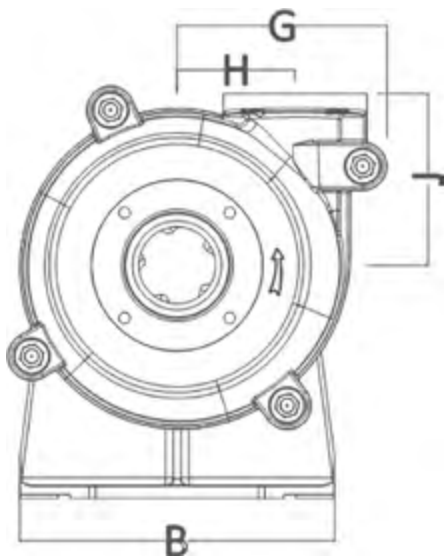

A	B	C	D	E	F	G	H
1021	492	364	330	164	424	406	229

J	K	L	M	N	U	Key size
338	11	0	219	65	65	18 x 11

All values in millimetres (mm)

NOTE This information is for guidance/reference only. For application specific drawings and curves, please contact your nearest authorised distributor at slurrypro.com